

GETTING TO KNOW YOUR CAMERA

Front View

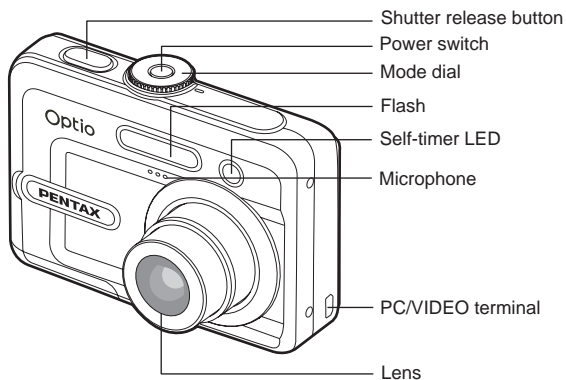

Name	Description
Shutter release button	Focuses and locks the exposure of the camera when pressed halfway down, and takes the picture when pressed all the way down.
Flash	Provides flash illumination.
Power switch	Turns the camera power on and off.
Mode dial	Sets the camera mode.
Self-timer LED	Blinks blue during self-timer mode until picture is taken.
Microphone	Allows you to record sound when recording movie clips.
PC/VIDEO terminal	Allows you to connect a USB cable or a video cable to the camera.
Lens	3x optical zoom lens allows you to take telephoto and wide-angle pictures.



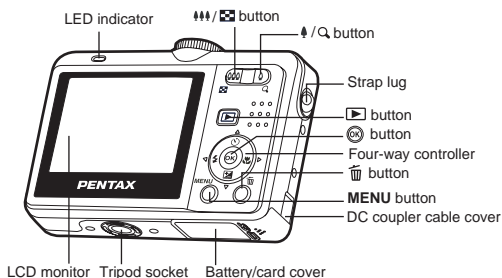



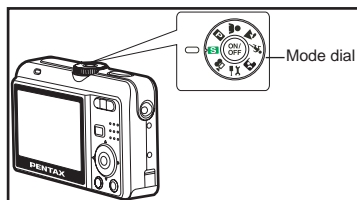

Rear View



Name	Description
LED indicator	Indicates the camera's current state.
Wide-angle button	Zooms the lens to wide-angle position. During zoom playback, it makes the enlarged image smaller on the LCD monitor. Changes the display into nine images (thumbnail) in the playback mode.
Telephoto button	Zooms the lens to telephoto position. During zoom playback, it makes the image bigger on the LCD monitor.
Playback button	Switches to Playback mode. The latest image and information appear on the LCD monitor.
MENU button	Switches to Menu settings.
DC coupler cable cover	Allows the DC coupler cable to pass through the opening when using AC adapter to operate the camera without battery.
Delete button	Allows you to delete the picture.
Four-way controller	Allows you to scroll through menus and pictures, and then select choices. <ul style="list-style-type: none"> ▲/☺ Selects the drive and self-timer modes in capture mode. ▶/🌿 Selects the focus mode in capture mode. ◀/⚡ Selects the flash mode in capture mode. ▼/☒ Moves to the EV compensation screen.
OK button	Confirms the menu item selection. Changes the LCD monitor display mode.
Strap lug	Camera strap attachment.
Battery/card cover	Allows you to access to the battery and insert or remove the SD memory card.
Tripod socket	Allows tripod mounting.
LCD monitor	Provides menu information to operate the camera, and previews the picture before taking it and review it afterwards.

Mode Dial



Mode	Description
 Simple	Lets you take still pictures without having to set special functions or manual adjustments. The camera sets the optimal focusing and exposure.
 Program	The basic picture-taking mode. You can let the camera set the functions or choose various functions yourself.
 Portrait	Lets you take portrait-type pictures.
 Landscape	Lets you take landscape views.
 Sport	Lets you take sport pictures.
 Night Scene	Lets you take dark scenes such as night views.
 Setup	Lets you select the camera preferences.
 Movie	Lets you take moving pictures.

GETTING STARTED

Attaching the Camera Strap

Attach the camera strap as shown in the illustration.

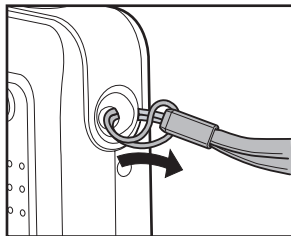

Inserting the Batteries

1. Open the battery/card cover.
2. Insert the batteries in the correct orientation as shown on the right.
3. Close the battery/card cover.

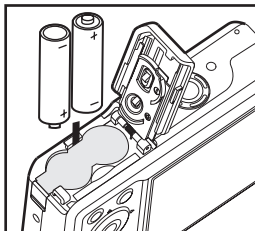

- You can use 2 AA size batteries (Ni-MH rechargeable or alkaline) to power the camera.
- Due to the characteristics of AA alkaline batteries, camera performance may deteriorate. AA alkaline batteries are not recommended except in emergencies and checking the camera's functionality.

Inserting the SD Memory Card (Optional Accessory)

1. Open the battery/card cover.
2. Insert the SD memory card in the correct orientation as shown on the right.
 - Hold the SD memory card with its metal contact end surface facing the rear side of the camera, and then insert the card as far as it can go.
3. Close the battery/card cover.

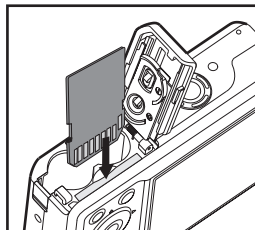

Turning the Power On

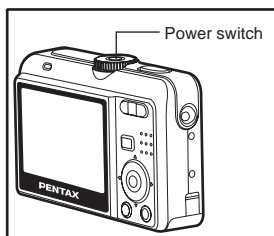

Press the power switch to turn the power on.





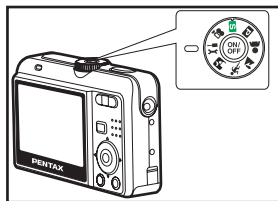

Choosing On-Screen Display Language

1. Rotate the mode dial to  and turn your camera on by pressing the power switch.

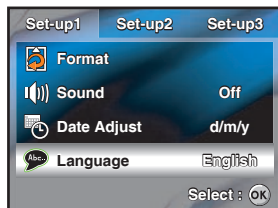

2. [Set-up1] is displayed.
3. Use the four-way controller () to select [Language], then press the  button.











4. Use the four-way controller ( ) to select the language you want.
5. Press the  button to confirm.



Setting the Date and Time

Follow the steps below to set the date display style, current date and time.

1. Rotate the mode dial to  and turn your camera on by pressing the power switch.
2. [Set-up1] is displayed.
3. Use the four-way controller () to select [Date Adjust], then press the  button.
 - [Date Adjust] is displayed.
4. Press the four-way controller () to select Date Style, Day, Month, Year and Time fields.
 - To increase a value, press the four-way controller ().
 - To decrease a value, press the four-way controller ().
 - To select the time display in 12-hours or 24-hours format, press the four-way controller ().
5. Press the  button after all fields are set.
6. Rotate the mode dial to any position other than .

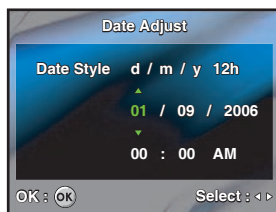
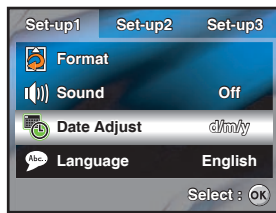

- The date illustration shown is for the purpose of explanation and may differ from the actual setting of your camera.

Taking Still Pictures

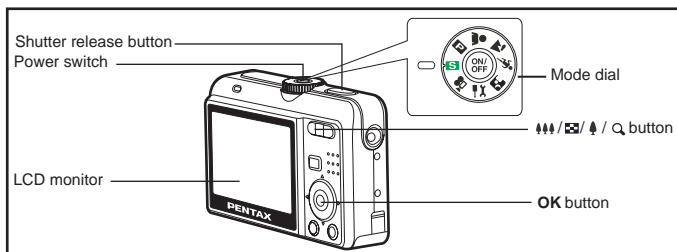

1. Set the mode dial to **S**.
2. Press the power switch to turn on the camera.
3. Compose the image on the LCD monitor screen so that the main subject is within the center frame (focus frame).
4. Press the shutter release button down halfway to focus the image. The focus frame turns green if the subject is in focus. Proper exposure is determined and locked at the same time.
5. Press the shutter release button down fully to take the pictures.

Playing Back Still Pictures

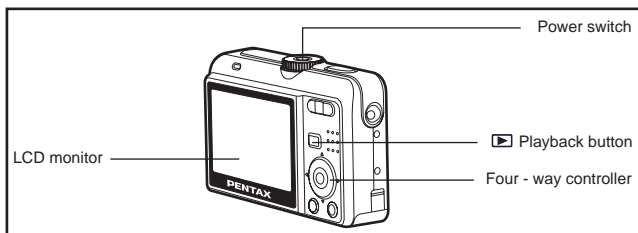

1. Rotate the mode dial to any mode other than **M** and press the **▶** button.
 - The last image appears on the screen.
2. Use the four-way controller (**◀▶**) to view the pictures.
 - Four-way controller (**◀**): go back to the previous image.
 - Four-way controller (**▶**): advance to the next image.

Recording Movie Clips





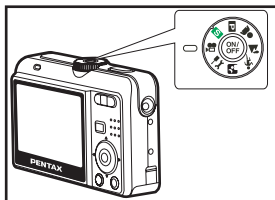

Movie mode allows you to record movie clips with sound via built-in microphone.

1. Rotate the mode dial to  and turn your camera on by pressing the power switch.
2. Press the shutter release button to start recording.
3. To stop recording, press the shutter release button again.













Playing Back Movie Clips

You can play back the recorded movie clips on the LCD monitor. However, the sound recorded with movie clips can only be played back on a TV or a computer.

1. Rotate the mode dial to any mode other than  and press the  button.
2. Use the four-way controller () to go through the images until the movie clip you want to play back is displayed.
 - To view the previous image, press the four-way controller ().
 - To view the next image, press the four-way controller ().
3. Press the  button to start playing back the movie clips.
 - To pause or resume movie playback, press the  button again.



Deleting Images

1. Rotate the mode dial to any mode other than  and press the  button.
 - The last image will be displayed on the screen.
2. Use the four-way controller ( ) to select the image you want to delete.
3. Press the  button.
4. Use the four-way controller ( ) to select [This Image] or [All Images] as your preference, then press the  button.
 - [This Image]: Delete one image/movie.
 - [All Images]: Delete all images/movies (at once).
5. When the delete message appears, use the four-way controller ( ) to select [OK], then press the  button to confirm the deletion.
 - If you wish to cancel the deletion, select [Cancel].

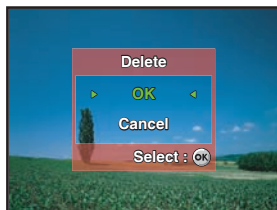



TRANSFERRING RECORDED IMAGES AND MOVIES TO YOUR COMPUTER

Setting Up Your Digital Camera

After installing the necessary software on your computer, you must now set up your digital camera to transfer images from the camera to your computer.

The USB driver included in the CD-ROM (S-SW60) is exclusively for Windows 98/98SE. For more details on driver installation process, you can refer to your Operating Manual. Windows 2000/ME/XP users don't need to install the USB driver.

Setting the USB Connection Mode to [PC]

1. Rotate the mode dial to  and turn your camera on by pressing the power switch.
2. Press the four-way controller (▶) to select the [Set-up2] menu, then use the four-way controller (▼) to select [USB Con.].
3. Press the  button.
4. Use the four-way controller (▼) to select [PC], then press the  button.

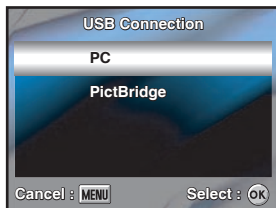
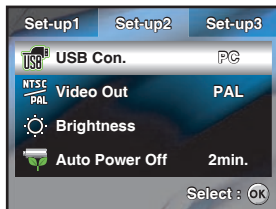

Connecting the Camera to Your Computer

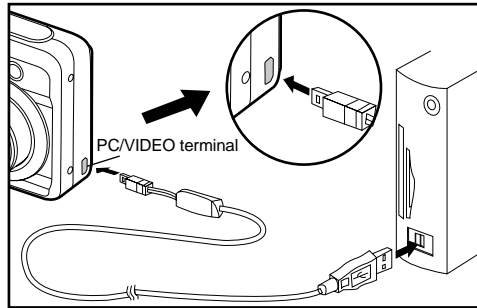

1. Connect the camera to the PC with the USB cable, making sure the shapes of input and output terminals match each other. If there is no SD memory card in the camera, the images stored in the internal memory will be transmitted to the computer.
2. Turn the camera on.
3. Look for a new "Removable Disk" icon appearing in the "My Computer" window. Your recorded images/movie clips will be in a folder on this "removable disk". (For Mac users, double-click the "untitled" disk on the desktop.)

Downloading Images/Movie Clips

When the camera is turned on and connected to your computer, it is considered to be a disk drive, just like a floppy disk. You can download (transfer) images by copying them from the “removable disk” (“Untitled” disk on a Macintosh) to your computer hard disk drive.

■ For Computers Running Windows

Open the “removable disk” by double clicking on it. Double click on the folder containing your recorded images/movie clips. Select the images/movie clips that you prefer and then choose “Copy” from the “Edit” menu. After that, open the destination location and choose “Paste” from the “Edit” menu.

■ For Computers Running Mac OS

Open the “Untitled” disk icon and the destination location on your hard disk. Drag and drop from the digital camera to the desired destination.

Specifications and external dimensions are subject to change without notice.